



featuring **RISE** Technology 

Refer to ESR 4731 for building code compliance and product design values. The report can be downloaded from the following location: <https://icc-es.org/report-listing/esr-4731/>

For all product installation questions, call customer service at (401) 490-4847. Be sure to use the latest version of installation instructions located at <https://www.risebuildingproducts.com/resources.html>

For detailed warranty information, refer to the substrate limited warranty at <https://www.risebuildingproducts.com/documents/RISE-Composite-Technologies-Substrate-Warranty-2022.pdf> and the paint limited warranty at <https://www.risebuildingproducts.com/documents/RISE-Composite-Technologies-Warranty-2022.pdf>

Install Rise Building Products consistent with the details in these instructions. Please contact customer service at the above number if you have any installation detail that is not covered in these instructions.

GENERAL PRACTICES:

1. **Store the products so they are flat, off the ground and protected from rain, dirt and other damaging conditions.** Unopened wholesale units of lap and trim stored in inventory may be stacked up to 6 units high. Do not stack panel siding more than 5 units high.
 - a. Product in storage or awaiting delivery should be stored under a roof, protective canopy, or shelter so it is protected from weather conditions that have the potential to damage the packaging and the product. **If the factory packaging is damaged, missing or removed; replace or repair the packaging promptly.**
 - b. Unopened units can be stacked up to 3 units high during transport by truck. Unload the siding/trim at the jobsite using a forklift. Rolling or dumping the product can damage the product and its factory primer or finish. Do not drag the siding/trim over itself or other surfaces. Take special precaution to preserve the quality of the factory coated surfaces.
 - c. Protect the product in storage or on the jobsite by keeping it thoroughly covered. This includes product that may be staged at different jobsite locations or on scaffolding overnight or during weather delays. **Keep the product dry and free from dirt and debris. It is important the product is dry during storage and installation to ensure paint adhesion, performance and avoid contamination.**
 - d. Avoid setting anything on the stored siding/trim to protect against damage to the finished surfaces. Do not stack opened units.

2. Install the border trim prior to the siding. Use the trim to create separations at roof lines and product intersections, and borders around walls, windows, doors and other wall penetrations.

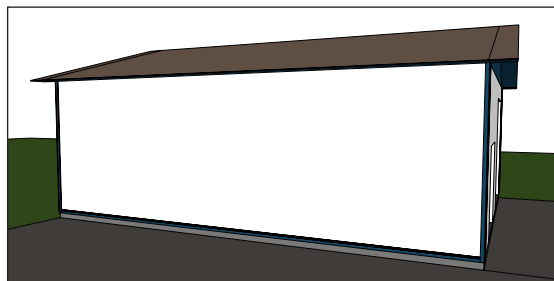

Figure 1 Wall bordered with trim

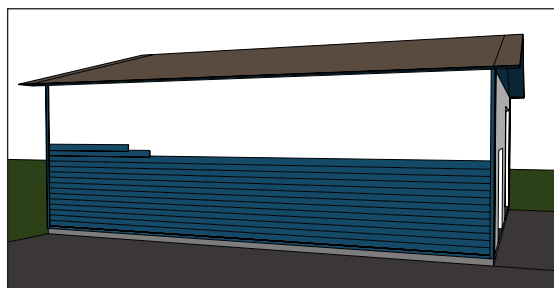

Figure 2 Lap siding in-fill

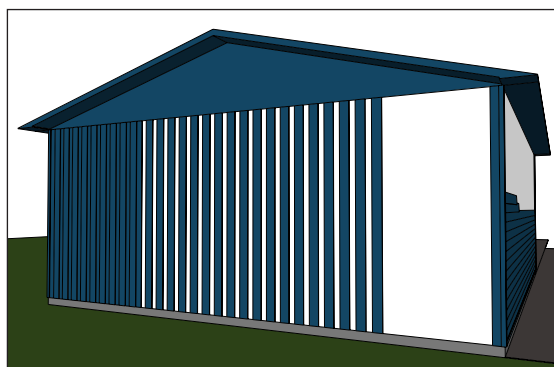

Figure 3 Board on board in-fill using vertically oriented lap siding

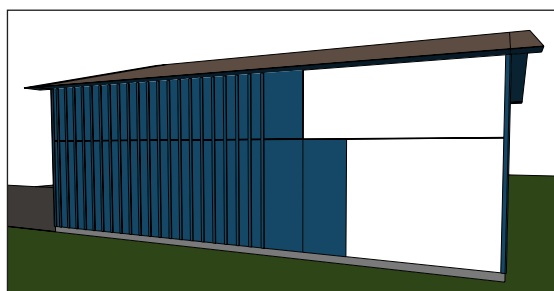

Figure 4 Board & Batten in-fill using panel siding and trim

3. Cut the siding and trim using the same tools normally used with wood. Use carbide tipped blades. Do not cut with damaged or dull tooling. Cut so the blade rotation is against the exterior face of the siding and trim.
4. Attach the trim and siding securely to the wall assembly according to these instructions and the specifications from your designer of record. Minimum fastener size and embedment must meet or exceed the requirements in ESR-4731. Consult your local code or authority for your prescribed wind zone. When installing over *rigid foam sheathing*, refer to table 2603.13.1 in the International Building Code or table R703.15.1 in the International Residential Code to determine the required fastener diameter, spacing and foam thickness limit. Increase the length of the fastener to ensure proper embedment as specified by these instructions and ESR-4731.
5. Flash as needed to release all incidental water from behind the siding. Incorporate the house-wrap (i.e. code approved water resistive barrier), flashing systems, and wall penetrations into a continuous integrated building envelope that protects against liquid water and air penetration into the wall assembly. Do not entrap moisture behind the siding or trim.
6. Paint all exposed substrate with a high quality exterior acrylic paint. It is not necessary to paint the back of the trim or siding or any areas that are well protected from direct weather (UV, rain, hail) exposure such as a caulk joint. Never apply paint when the air temperature and product surface temperature is below the paint manufacturer's prescribed limit. Follow the paint and sealant manufacturer's instructions for quality results.

LET'S GET STARTED:

Begin with the eave or cornice. Install the fascia and gable rake first to create a border for the roof and eave assemblies. Properly flash and cap parapet walls as instructed by the manufacturer of the metal coping system. Integrate the metal drip edge on sloped roofs with the roofing manufacturer's instructions. Utilize gutters and kick-out flashings to direct liquid water away from the structure.

Next, use Rise trim as soffit to finish the eave. Vent the soffit as required by your local code and your designer's specification.

Once the eave is complete, install the vertical trim to border the ends of the walls, wall penetrations, and terminations adjoining other exterior cladding materials or accents. Take the necessary time to consider any height variations or wall details that might affect the siding installation and final architectural finish. Install horizontal trim and frieze boards to complete the borders. Be sure to maintain transitions from wall to wall so the horizontal lines of the belly trim enable the lap siding to match evenly at corners. Properly flash horizontal materials so liquid water is able to drain from behind the siding to the exterior environment. Do not caulk or terminate drain points intended for moisture evacuation.

Fill in the area bordered by trim with Rise siding. Fasten and space the siding according to these instructions. Do not overdrive the fasteners. Expansion and contraction of building materials and building assemblies is natural. Space the siding and adjoining materials according to the details of these instructions. Failure to properly space material can cause undue stresses on the structure and its components resulting in unwanted consequences.

Flash all openings, penetrations, and other areas where water will collect or travel. All horizontal trim and transitions between materials must be flashed per these instructions and the flashing manufacturer's instructions. Do not caulk or dam water at drainage points.

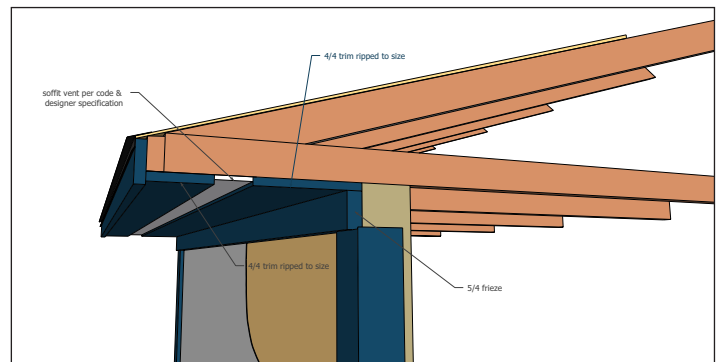
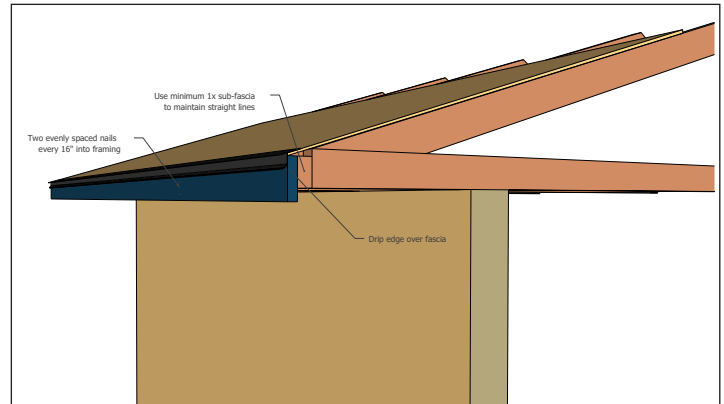

Install a starter strip before installing lap siding. Maintain 3/8" clearance between strip and horizontal flashing. The starter strip can be ripped from the Rise lap siding. Wood, pvc and other materials can also be used. The thickness of the starter strip should be equal to the thickness of the lap siding.

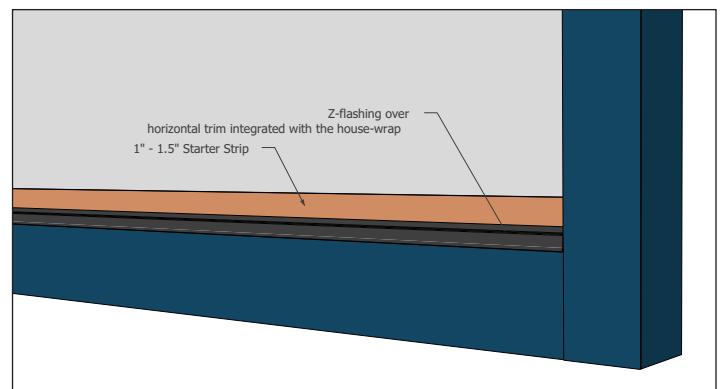

Caulk according to these instructions using a minimum class 25 ASTM C920 sealant. RISE has been color matched for both the OSI and DAP caulk products. See Paint & Caulk Color Match Chart for details.

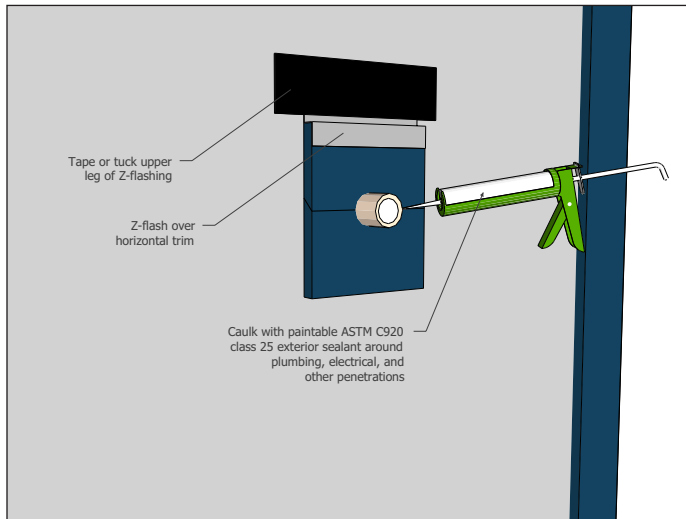

Install house-wrap or combined panel/barrier systems according to their respective manufacturer's instructions and the local code. Apply all flashings and wall penetrations to create a continuous building envelope to resist water and air penetration.

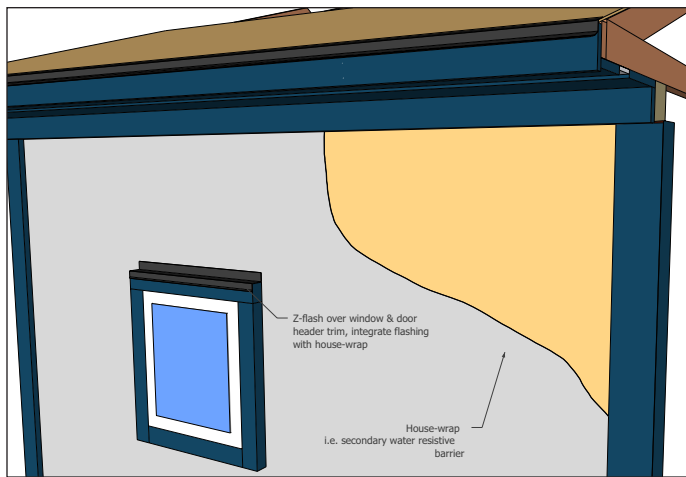

Overlap siding 1-1/4" or more. Conceal the fasteners in the lap joint. Place the fasteners a minimum of 1" from the top edge to maintain a tight lap joint between courses. Do not rip the siding for smaller reveals. Increase the overlap and build out the trim so remains proud of the siding.

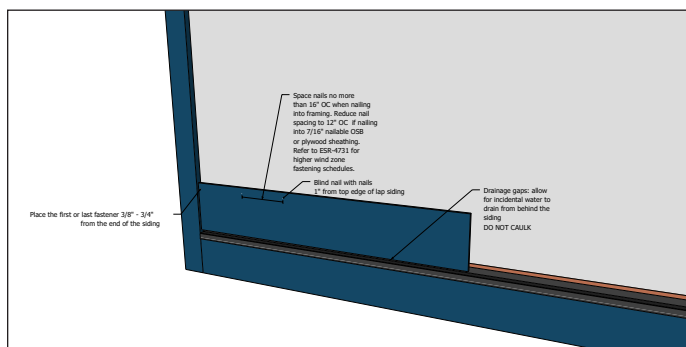

Maintain a 3/8" drainage gap over horizontal wall flashings to direct water to the exterior. Dam the ends of the horizontal flashing with sealant to direct water to the exterior. Never caulk the full length over horizontal wall flashing. Do not entrap water behind the siding.

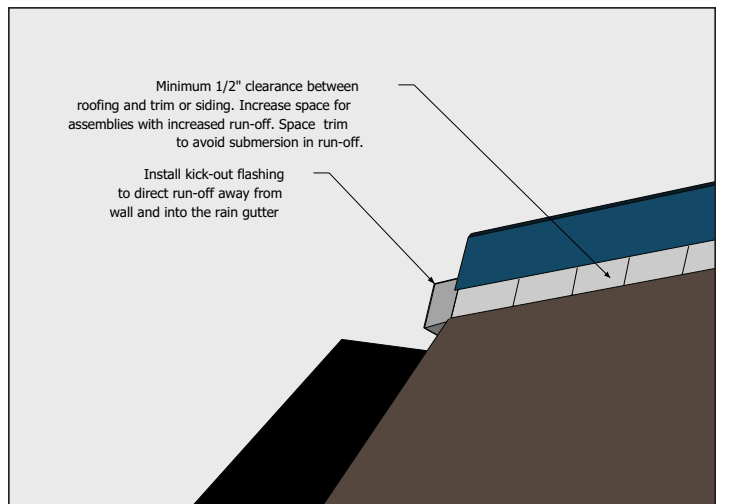
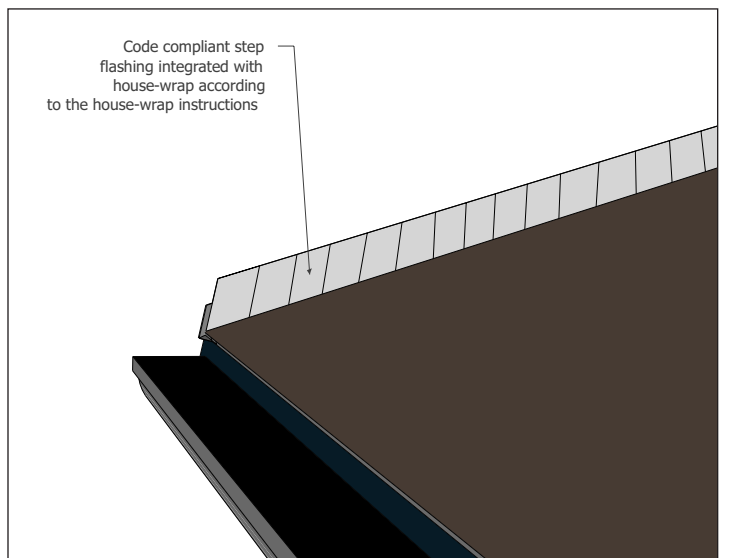
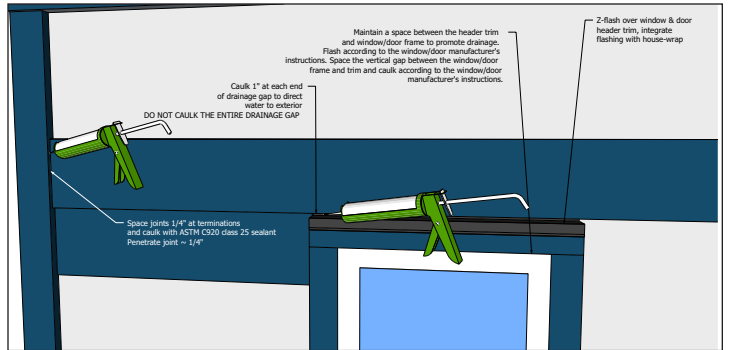

Securely attach all Rise products per these instructions. Do not place fasteners less than 3/8 inch from any end of trim or lap and edge of panel. Refer to ESR-4731 for additional fastening requirements to meet various wind zone requirements.

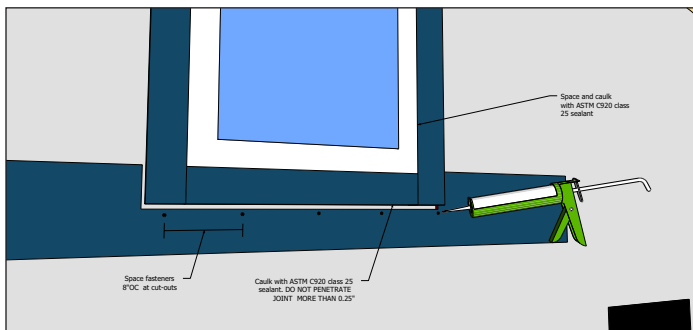
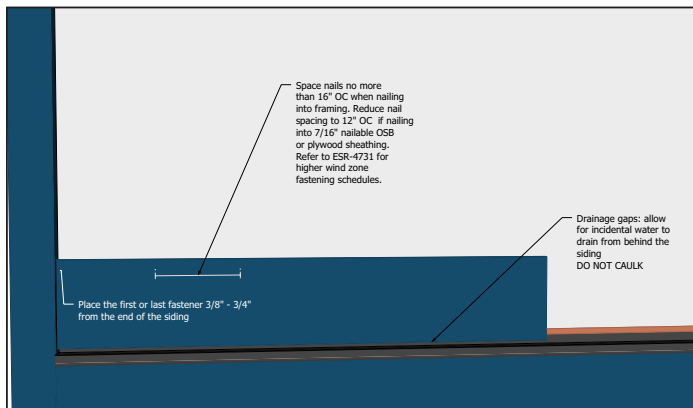
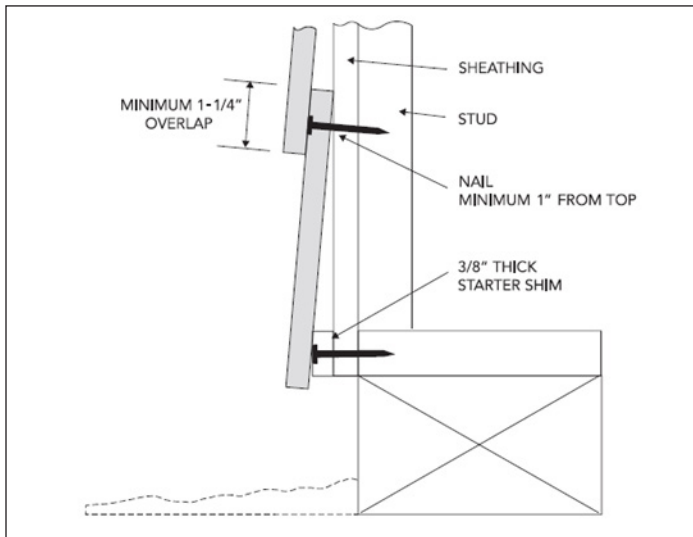
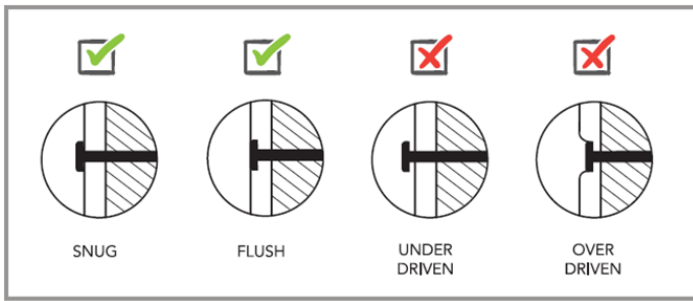

Fasten batten strips, and vertical lap siding with a pair of nails at each end. Place intermediate fasteners at 12" OC along alternating edges. This will result in a single course of fasteners along each edge that are spaced a maximum of 24" OC.

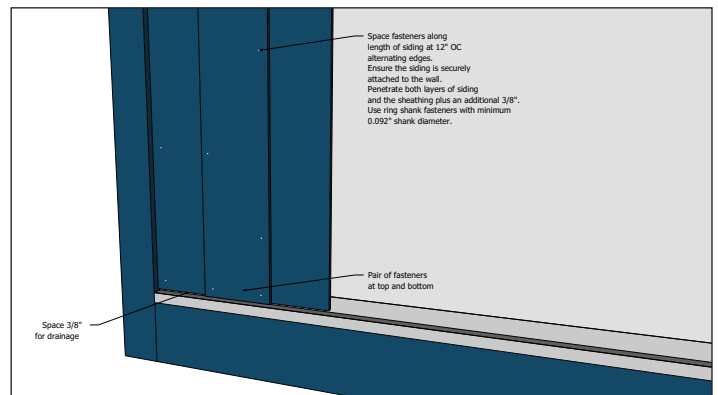

When bridging floor assemblies, fasten trim and vertical lap siding with a minimum of two fasteners in the upper portion of the rim board and another pair of fasteners into the lower portion of the rim board. Avoid fastening into the bottom or top plates.

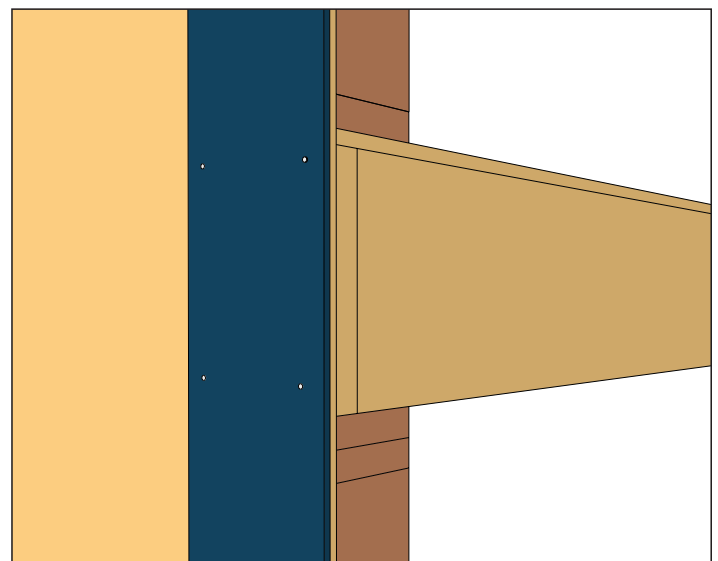

Horizontal trim up to 8" wide fastened to framing requires two fasteners per stud. Wider trim requires three evenly spaced fasteners per stud. Maximum stud spacing cannot exceed 16" OC.

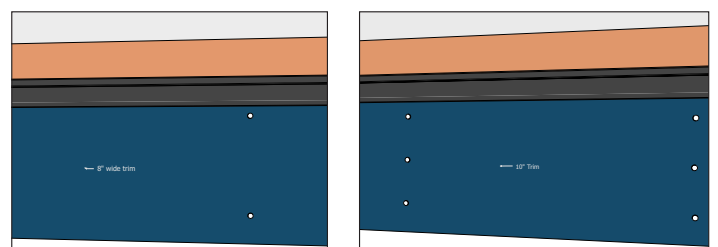

*Fasten Lap siding installed in a slat-wall application using the 8" trim fastening schedule. Flash the top of each piece of siding using the same method described in these instructions for trim.

Space joints at terminations $\frac{1}{4}$ " and caulk with class 25 ASTM C920 sealant. This applies for both panel and lap siding. Terminations include vertical trim or other materials adjoining the siding.

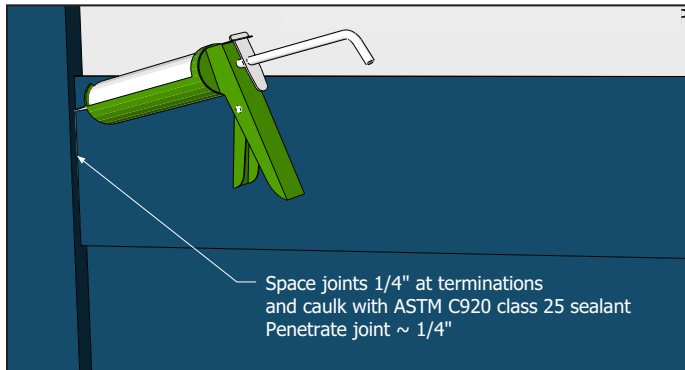

Flash butt joints with a code compliant material to shed moisture to the exterior and protect the house-wrap from direct UV exposure. Paint the ends of the siding thoroughly with a durable exterior acrylic paint. Butt joint may be covered with a metal joint clip.

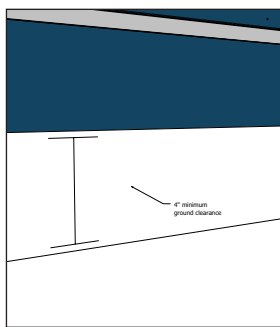
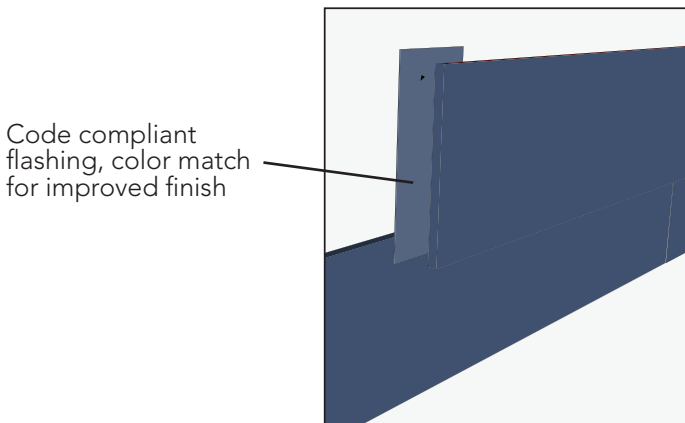

Space siding and trim 4" minimum above landscaping and $\frac{1}{2}$ " minimum above finished surfaces with a water draining slope and protected overhang.

Best practice is 4" minimum ground clearance. Light ground contact is acceptable at sloped draining grades or surfaces where required to meet architectural specifications.

Reduced ground clearance or light ground contact will likely increase the frequency for needed coats of maintenance paint. Reduce the potential for paint erosion by directing moisture away from the area with overhangs that include gutters or other drainage systems.

ANNUAL WEATHER THERMAL CYCLING

Rise Siding and Trim products are extremely durable in exterior applications, due to the synthetic fiber composite core. During the course of a year in many areas of the country, in direct sunlight exposure, the temperature of sidings can vary over 140 degrees. As a result, Rise siding and trim products will expand and contract in length seasonally. To permit this movement, important spacing instructions are below. Customers will notice in cold winter months, installed product spacing gaps will widen, and in hot summer months they will close.

The seasonal temperature shifts can cause a 160" siding or trim board, to expand or contract to a maximum of .175" in each direction after installation at 70 degrees. Total movement in a 140 degree change can be approximately .35" or two tenths of one percent in length. Although impressively low compared to similar materials, it does require the installation spacing shown below to ensure proper performance of RISE Siding and Trim.

Space butt joints of lap siding and trim according to the following table. For trim, this is most critical when installing full length pieces end to end in horizontal applications. For trim that is field cut to shorter lengths, a proportionate gap is recommended and pieces under 6' can be lightly butted.

LAP AND TRIM SPACING REQUIREMENTS	
Temperature of RISE material when installed	Spacing
Under 0F	Do not install
0-40F	.25" or $\frac{1}{4}$ "
40-80F	.1875" or $\frac{3}{16}$ "
Over 80F	.125" or $\frac{1}{8}$ "

PANEL SPACING REQUIREMENTS		
Temperature of RISE material when installed	Horizontal Spacing	Vertical Spacing
Under 0F	Do not install	Do not install
0-40F	.25" or $\frac{1}{4}$ "	.125" or $\frac{1}{8}$ "
40-80F	.1875" or $\frac{3}{16}$ "	.125" or $\frac{1}{8}$ "
Over 80F	.125" or $\frac{1}{8}$ "	.125" or $\frac{1}{8}$ "

BOARD AND BATTEN

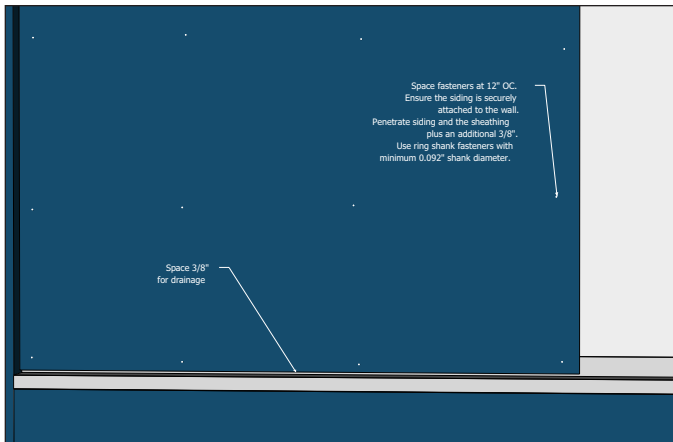

Fasten panel siding over a nail-able base such as 7/16" OSB or plywood. Flash the top of the panel with z-type corrosion resistant flashing. Cover the edges of joining panels with a corrosion resistant track or batten strip. Install the aluminum track and flashing according to their manufacturer's instructions and local code. Space vertical and horizontal edges 0.25"

Add space to account for any flashing or vertical tracks.

TOUCH-UP AND PAINTING

- Touch-up applicators can be provided to match the finish of the siding. Touch up kits are available for purchase with your siding.
- Porcelain White RISE Trim, and all RISE siding colors can be purchased at your local paint store. Please refer to RISE Paint & Caulk Color Match Chart, or www.risebuildingproducts.com, for current colors.
- If primer touch up is needed, use 100% acrylic exterior primer followed by 100% acrylic exterior paint. It matters little about the solids and such, as long as it is exterior grade, and 100% acrylic (latex is equivalent to acrylic).

CLEANING

- It is recommended to wash RISE Siding and Trim during the hottest and driest time of the summer. This allows for quick drying, which will help avoid mold and mildew growth.
- If dirt or other debris collects on the surface of the siding or trim, wash with a sponge, cloth or light bristle brush – the type of brush that is used on cars. **DO NOT POWER WASH THE SIDING.** Power washing can damage the siding and other wall components.
- Use a light detergent and water mixture as per the detergent manufacturer's directions. Avoid abrasive cleansers.
- Rinse the siding and trim with a garden hose and spray nozzle, or a power washer set to the largest fan setting.
- For stubborn mildew, mix a solution of 1 part bleach to 3 parts water into a garden sprayer attachment and spray the affected areas with the solution.